

Silage and multipurpose
loader wagons with rotors
FARO / FARO COMBILINE

 **PÖTTINGER**

All-rounder with the latest technology



All-rounder with the latest technology



FARO / FARO COMBILINE

The FARO 3510, 4010, 4510 and 5010 loader wagons made by PÖTTINGER are in the mid-sized segment between 90 and 150 hp. The 31 knife bank and powerful rotor drive for higher capacity give these new FAROs a high output.

The high capacity FARO 8010 / 10010 DRY FORAGE loader wagons are in a class of their own and have been especially developed for dry crop specialists.

The FARO 4010 COMBILINE can also be used as a harvest transport wagon, turning it into a cost effective all-rounder.

Table of contents

The highest forage quality	4-9
The best silage quality	10-13
Efficiency	14-21
Cost effectiveness	22-25
Reliability	26-33
FARO	34-37
FARO COMBILINE	38-43
FARO DRY FORAGE	44-49
Digital agricultural technology	50-53
Intelligent operation and ISOBUS terminals	50-51
agrirouter	52-53
Accessories	54-55
Technical data	56-57
MyPÖTTINGER / ORIGINAL PARTS	58-59

All information on technical data, dimensions, weights, output, etc. and the images shown, are approximate and are not binding. The machines shown do not feature country-specific equipment and may include equipment that is not supplied as standard, or is not available in all regions. Your PÖTTINGER dealership would be pleased to provide you with more information.

The highest forage quality



The best forage quality is the basis for your success

High yield dairy cattle need a high quality basic ration with the optimum structure. This is readily consumed by the animals in sufficient quantities. That is the best way to prepare the rumen to process the forage as productively as possible. High base forage quality reduces dependence on concentrates and promotes animal health, both of which lower your costs.

Healthy cows will thank you with improved fertility levels and higher milk yields over a longer period of time. The bottom line is that you benefit from clean, high quality forage with higher profits from your dairy business.

The best chopping quality and chopped length

In addition to the great importance of the optimum dry matter content, the chopped length of the forage has a significant influence on the quality of the grass silage. Shorter chopped forage reduces the rumination time and makes it easier for the rumen to process.

Both parameters lead to faster pH reduction, which reduces the risk of fermentation errors and has a positive effect on the stability of the grass silage. This lays the foundation for high dry matter intake.

FARO / FARO COMBILINE



The best chopping quality with a chopped length of 45 mm

The FARO is the ideal choice for high forage quality thanks to the chopping system with 31 knives and a theoretical chopped length of 45 mm.

The forage has the optimum structure for ruminants.

An optimum distance between the knives and tines ensures smooth operation and protects the knives from foreign objects.

Healthy animals as a key element to success

"It has become clear to me that with the short chop loader wagon, grass silage can be made more efficiently and milk can be produced more efficiently, so that the farm generates more profit. In order for the cows to produce a high milk yield, the animals must be completely healthy..."

Colin Bowen
Farm Manager
Church Stretton | Great Britain

The highest forage quality

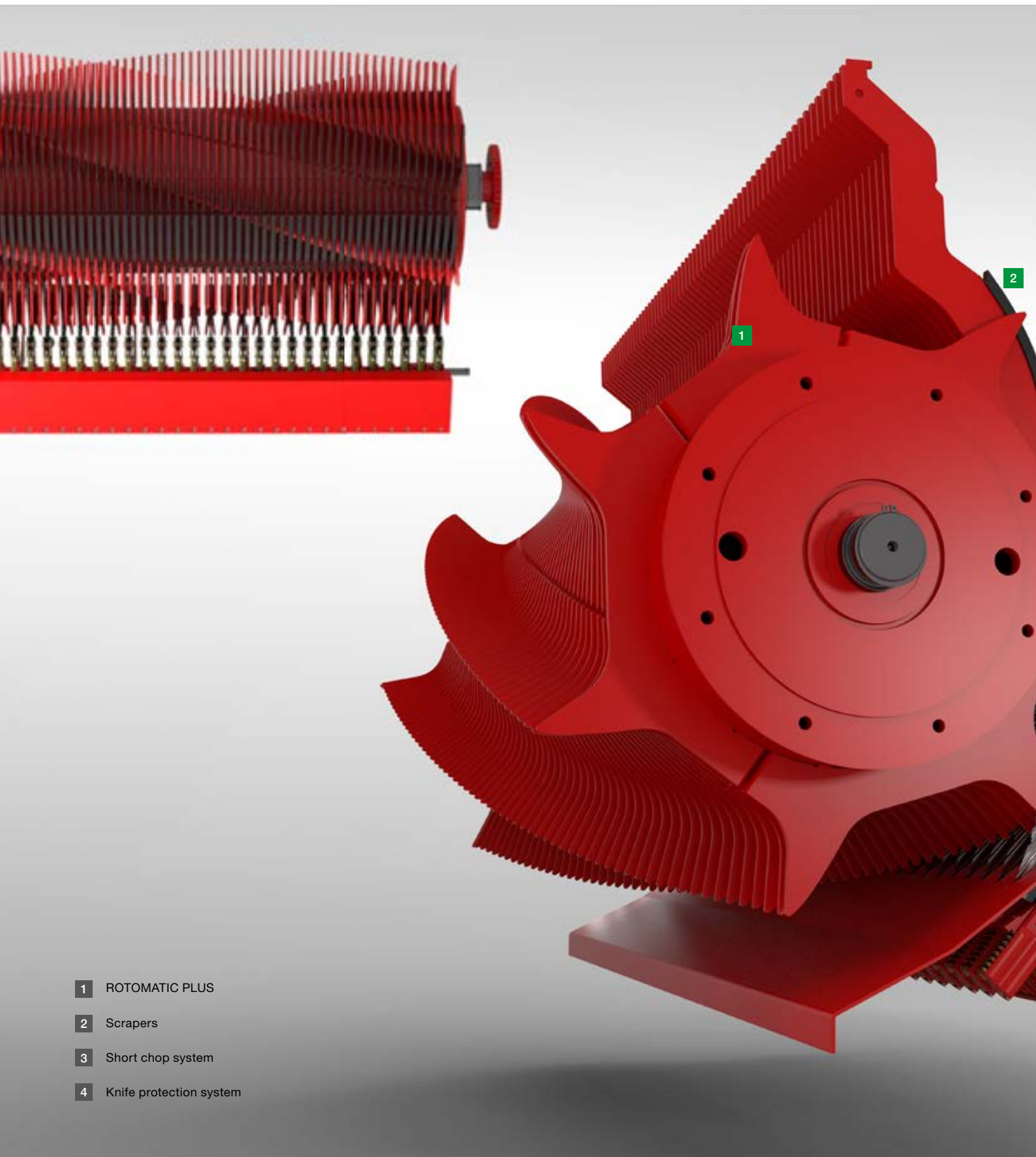

- 1 ROTOMATIC PLUS
- 2 Scrapers
- 3 Short chop system
- 4 Knife protection system

FARO / FARO COMBILINE

ROTOMATIC PLUS

The loading rotor with a diameter of 750 mm achieves a high throughput during chopping, conveying and compacting. The 7 mm thick conveyor tines are made of durostat hardened and tempered boron steel and feed the crop perfectly into the chopping system.

Short chop system

With a theoretical chopped length of 45 mm

Knife protection system

The reliable knife protection system protects the loader wagon from foreign objects, avoids downtime and promotes a consistent chop length for the highest possible forage quality.

Scraper beam

The large scraper area inside the loading chamber ensures excellent conservation for all types of forage. This makes the FARO highly suitable for mixed farming operations.

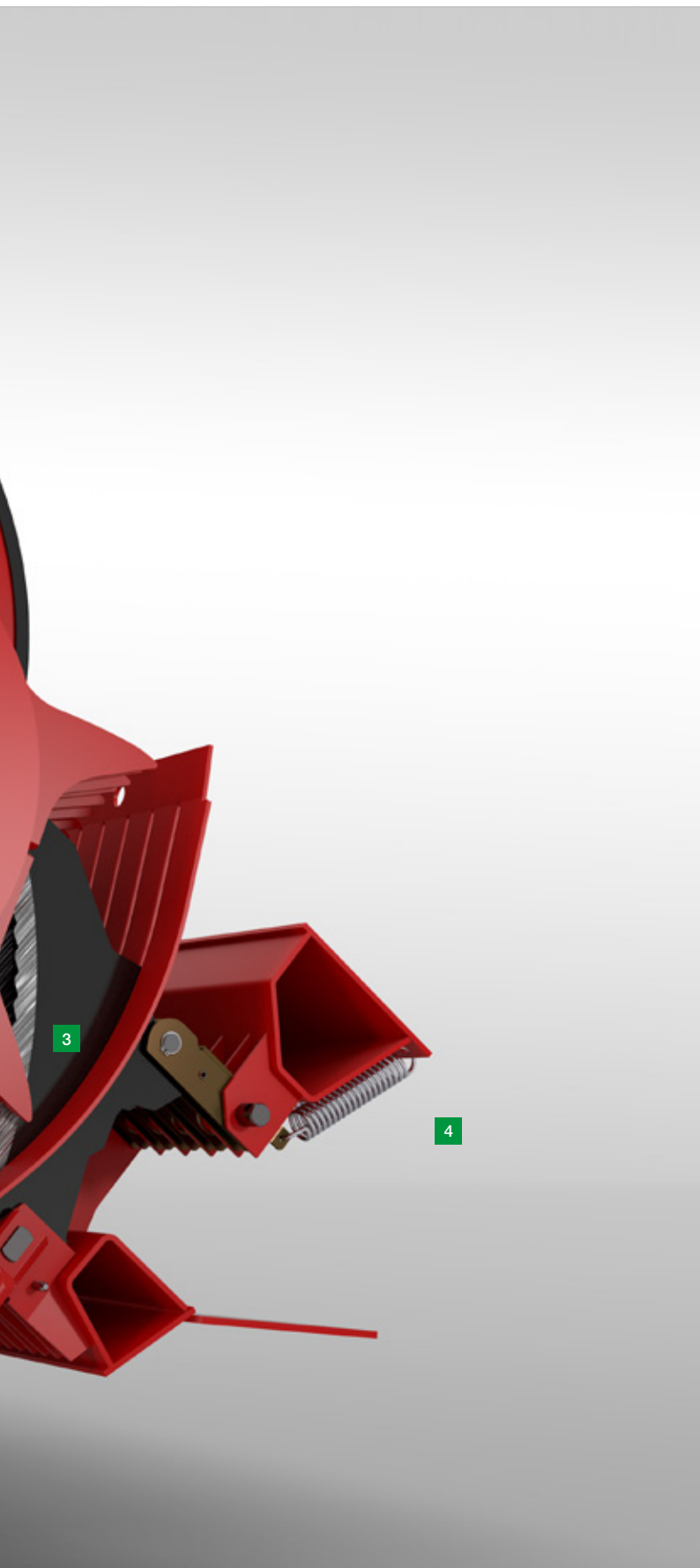

The highest forage quality



A controlled pick-up for clean forage

The sealed twin-race roller bearings fitted to the cam rollers are designed to withstand high stresses. With the sweeping action of the tines on the pick-up, it conserves the sward, lowers the level of dirt ingress and prevents unnecessary wear to the tines.

The pick-up with perfect ground tracking for the lowest possible crude ash content makes the loader wagon particularly suitable for harvesting forage.

Clean forage

The interaction of the controlled pick-up with the floating pick-up suspension and the low pressure on the ground results in the cleanest possible collection of the crop. This ensures the contamination level is within the limit values of 80-100 g / kg of dry matter.

Perfect forage flow

An optional wind guard with swath roller and guide plates ensure perfect forage flow with every type of crop, even at higher loading speeds.

Tidy transfer

The fully active tine leg length on the controlled pick-up transfers the flow of crop smoothly to the rotor, even in difficult harvest conditions.

Best chopping quality

Instead of dragging the forage through, the system promotes the best possible chopping quality.

FARO / FARO COMBILINE



Perfect ground tracking for a low crude ash content

The two support arms on the pick-up as well as the height adjustable trailing jockey wheels ensure perfect ground tracking. In addition, weight alleviation springs are provided as standard to ensure a low ground pressure of around 100 kg.

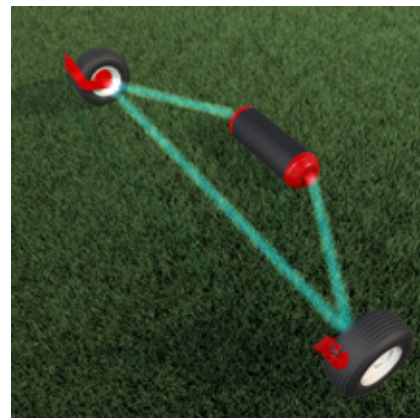

Additional tracking roller for the highest forage quality

The optional additional tracking roller prevents the pick-up sinking into tractor wheel marks. It is located on the centreline behind the pick-up and covers a wide area of ground thanks to its generous dimensions. Together with the two jockey wheels, the additional tracking roller forms a support triangle for perfect ground tracking.

This considerably reduces the tines scraping the soil so contamination of the forage is avoided.

Unique parallelogram guidance

The parallelogram linkage on the pick-up leads to significantly better ground tracking. This means that you get clean forage even in difficult conditions, and the freedom of movement of the pick-up is still 100%.

The working height is adjusted independently of the front jockey wheels.

Support triangle

The two jockey wheels and the optional additional tracking roller form a stable support triangle. This significantly increases the area of ground contact and ensures perfect crop collection even in bumpy terrain.

The best silage quality



A high quality basic ration is the basis for healthy animals

Healthy cows perform better, provide more milk with a higher quality and ensure more profit.

The choice of the right harvesting method has a great influence on the quality of the forage and is the prerequisite for bringing in forage with a high energy content.

Basically, all the machines in the harvesting process should be designed to meet the high requirements of forage conservation, ground tracking and high output. To ensure that the ensiling process achieves the best quality, it is important that a large quantity of forage is handled efficiently.

Machine performance needs to be matched to the fields being harvested and the compaction vehicle in the clamp needs to be suitable to handle the rate of crop being delivered.

Even distribution and rolling in the clamp is usually the bottleneck in the harvest chain, since the machine performance available in the field is generally greater than the performance of the machinery in the clamp. This means that the speed of harvesting is actually determined by the machinery working in the clamp.

The rolling weight required when using the loader wagon should correspond to about one third of the material harvested in tonnes of fresh crop per hour.

FARO / FARO COMBILINE



Metering on demand

A uniformly distributed blanket of forage is essential for perfect compaction. Two beater rotors guarantee perfect distribution. The aggressive tines deliver an impressive performance, even with highly compressed forage. Bars on the rotors also ensure maize material can be unloaded effectively. A pressure sensor in the beater rotor bearings controls the scraper floor automatically.

Beater rotor driveline

The driveline to the beater rotors is concealed within the frame. The strong drive shaft is protected by a cam-type clutch at 1200 Nm.

Making the best silage

"I was impressed with the chopping quality of the FARO 4510, both for silage making and for harvesting dry forage. Its strong construction, smooth running and simple operation make it fun to work with. As a medium-sized dairy farm, the good price-performance ratio enables us to bring the best forage into the silo when we want, and above all on our own..."

Klaus Oberhofer
Farmer
Bad Waldsee | Germany

The best silage quality



EASY MOVE swing-out knife bank

There is no easier way to change the knives. The EASY MOVE knife bank swings out alongside the wagon to ensure ease of use. Change knives conveniently at the side of the loader wagon. This unique swing-out knife bank makes light work of changing the knives.

Pressing the swing-out button on the side of the wagon brings the chopping system into the swing-out position. Remove the interlock pins and detach the pivot cylinders from the knife bank. Detaching the cylinders releases the chopping system. Now you can simply pull the knife bank out alongside the wagon.

Easy accessibility

Thanks to EASY MOVE, the knives are changed outside the loader wagon - no bumping your head, no bending over to work under the loader wagon.



Highest quality knives

The knives are produced from hardened tool steel and their ground serrated edge ensures a precise chop. The extra thick rear edge of the knife guarantees an extended service life.

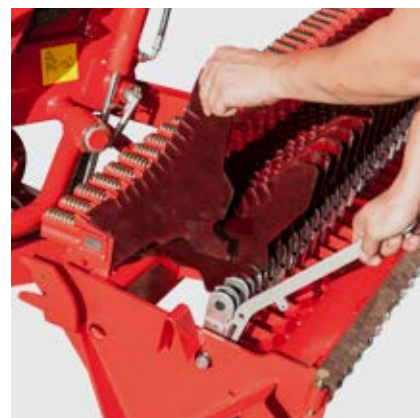
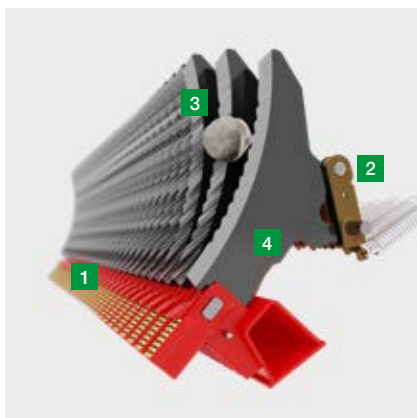
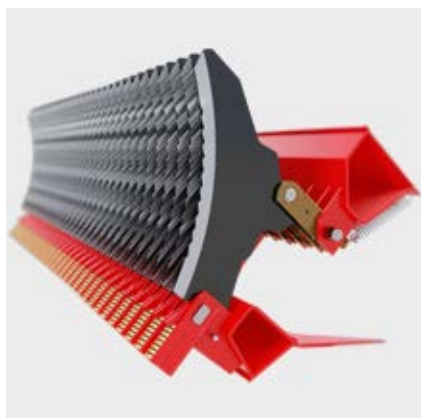

Ensuring knife protection

PÖTTINGER protects your loader wagon with the patented SUPERMATIC individual knife protection system. Foreign objects are a danger to the rotor and chopping system. Downtimes are costly and reduce the quality of the forage.

The triggering force is adapted to the high throughput capacity. The knives are held in the correct position to make sure that they chop consistently.

- 1 Foreign objects trigger the protection system. The knife moves in the direction of crop flow.
- 2 The trigger roller is lifted out of its holder behind the knife.
- 3 The resistance of the knife is suddenly reduced so that the knife can allow the foreign object to pass through. The sharpness of the knife is retained.
- 4 The knife is automatically brought back into the working position.

Any stones in the forage are not pulverised. The cattle leave them in the trough so that injuries to the digestive system are avoided.

Easy knife changes

Real convenience - use the quick-change lever to move the retention roller back and remove each knife.

Efficiency



Efficiency and high output

Rotor technology is now available for medium-sized farms and for tractors up to 150 hp.

In addition to forage quality, the key requirements are high output and smooth running for low diesel consumption. These characteristics make the FARO the perfect loader wagon for medium-sized farms.

Forage conservation at the highest level

In order to conserve the forage, PÖTTINGER implements more technical innovations such as the automatic loading system. This delivers in a smooth force curve without torque peaks during loading and the forage structure remains intact.

The automatic loading system guarantees that the wagon is filled to achieve maximum transport capacity. The forage is already carefully compressed in the transfer throat to make full use of the loading chamber.

This is standard on the FARO 4010 COMBILINE and FARO 8010 L / 10010 L.

FARO / FARO COMBILINE

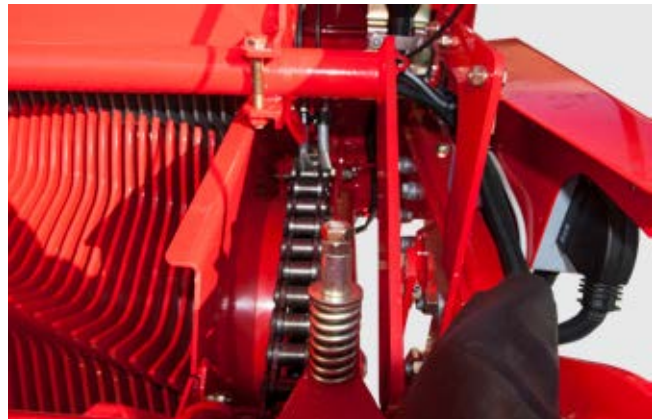

Power transmission up to 1600 Nm

The FARO's drive train has been designed for a tractor power of 90 to 150 hp.

They are driven by a wide-angle PTO shaft and a cam-type clutch to protect the driveline.

The 1 1/2 inch simplex high performance chain with automatic tensioner transmits power to the loading rotor.

The FARO also features automatic chain greasing for the rotor and pick-up.

Efficiency



A controlled floating pick-up

Maximum intake

The PÖTTINGER pick-up guarantees maximum feed rate. The transfer zone from the pick-up tines to the rotor has been optimised and adapted for high throughput capacity. The PÖTTINGER floating pick-up with six rows of tines delivers impressive performance, even at high driving speeds and in difficult harvest conditions reliable and high intake performance is achieved.

Perfect ground tracking

Two support arms ensure the pick-up has complete freedom of movement. A spring alleviates the pick-up weight so less pressure is exerted on the ground. Height adjustable jockey wheels contact the ground on precisely the same line as the tines to ensure perfect ground tracking and cornering.

FARO / FARO COMBILINE

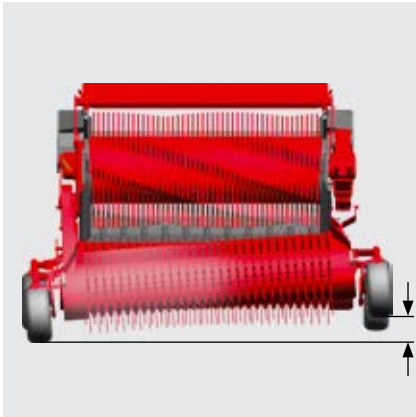

150 mm travel path

With a vertical travel of 150 mm on the pick-up, PÖTTINGER ensures perfect ground tracking and exact contouring.



Multifunction tailgate

The loader wagon is equipped with unloading beaters and a multifunction tailgate.

- Normal unloading: Tailgate wide open
- Fine dosing: unloading with beaters
- Cross conveyor belt mode

The adjustable flow control board swings upwards when the tailgate opens to prevent forage loss.



Cross conveyor belt

For depositing the daily forage ration inside the cattle shed, we offer a powerful cross conveyor belt with a width of 890 mm. This enables rapid forage delivery when needed. Available as an option on all FARO D models.

- The direction of the belt can be controlled from the terminal
- Hydraulic powered
- Tailgate locking system with tailgate open
- Optional on-board hydraulic unit if tractor outputs less than 80 l/min

Efficiency

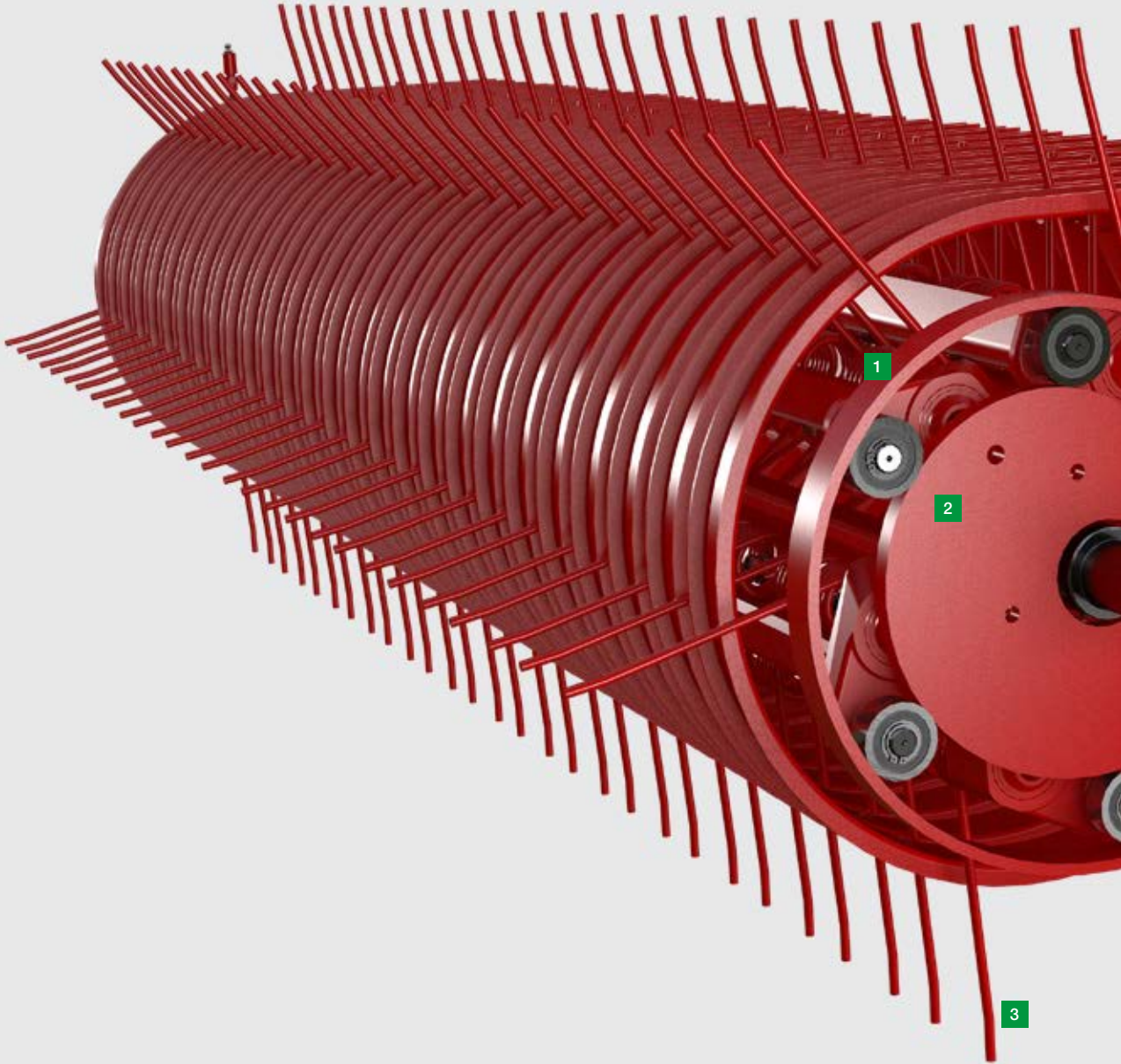

- 1 Cam track
- 2 Solid core
- 3 Pick-up tines
- 4 Scrapers

FARO / FARO COMBILINE



A controlled floating pick-up

Maximum intake thanks to the 6-row PÖTTINGER floating pick-up.

Cam track at both ends

The shape of the cam track ensures optimum movement of the tines. This ensures the trailing tines pick up the forage at the correct angle. They convey the crop gently upwards, actively transfer the crop to the rotor at an adjusted speed and at the defined transfer point. The tine dips down at a right angle to prevent the forage from being drawn in. The cam tracks with solid cores at either end of the pick-up guarantee a long service life and maximum efficiency.

Pick-up tines

The tines are slightly trailing to sweep in a controlled arc and adapt ideally to contours. Clean forage is guaranteed as a result. The fully active tine length up to the withdrawal point ensures the forage is transferred to the rotor perfectly. Thanks to the reduced speed of the rotor, the forage is not dragged but fed actively into the rotor. Maximum conveying performance at high driving speeds. Reliable high intake performance, even in difficult harvesting conditions.

Full freedom of movement

Two support arms and a special universal joint ensure the pick-up has complete freedom of movement. The universal joint ensures smooth guidance of the pick-up so that it can collect crop cleanly even on bumpy terrain.

Efficiency



ROTOMATIC PLUS

ROTOMATIC PLUS is the heart of the FARO range. Rugged and powerful, the rotor delivers high output chopping and compression. ROTOMATIC PLUS represents smooth, efficient chopping of the crop and perfect transfer from the pick-up.

- Loading rotor with seven rows of double tines arranged in a helix, diameter: 750 mm
- The loading rotor is mounted on self-aligning ball bearings at both ends
- The bearings between the rotor and the rotor drive frame protect the bearings and drive chain

Optimised tine geometry

The double conveyor tines made from hardened durostat 500 fine-grained steel are 7 mm thick and ensure maximum performance, even with short, wet forage. The optimised tine shape and large scraper surface ensure the best possible compression in the loading chamber.

The tine rings are hooked into the central drum and welded around the circumference for exact positioning. The scrapers have an 12 mm wide rear face and are individually mounted and bolted. They ensure highest possible compression, depending on how the automatic loading system is set.



Lowered scraper floor

The scraper floor has been lowered by 150 mm at the front end. As a result, the forage is pushed upwards as it moves to the rear. This ensures smooth, hassle-free unloading as well as a low power requirement.

four powerful drive chains ensure rapid unloading. The tempered slats are separated and offset.

The load chamber floor is constructed of pressure-impregnated, durable wood. This has excellent gliding properties for all types of crop.



Scraper floor drive system

The powerful hydraulic motor is located on the side of the wagon and delivers a reliable output. The speed of the motor is infinitely-variable controlled.

A two-speed motor is available as an option for driving the scraper floor.

- An infinitely-variable motor for unloading speeds of up to 16 m/min. is standard
- A two-speed motor is available as an option for unloading speeds of up to 20 m/min.



Automatic unloading

The automatic unloading system makes life a great deal easier for the driver and protects the machine. It controls the tailgate, scraper floor and, on the D model, also the beaters. The unloading process can be stopped and started again whenever needed.

Cost effectiveness



The cost effective process

The loader wagon can carry out the operations of crop take-up, chopping, compaction and transport in one machine. That is why the loader wagon is often referred to as a two-person harvest system. Modern loader wagons are generally offered as multipurpose loader wagons so they also meet the requirements of a fully-fledged transport wagon. Because of their flexibility (loading and transport), the machine achieves optimum utilisation.

The loader wagon process guarantees the best quality forage and silage at low harvesting costs, making it the harvesting process of the future.

FARO / FARO COMBILINE



Soil conservation with high performance technology

Increasing loading volumes, greater field to farm distances and high transport speeds call for a strong and soil conserving chassis, high quality tandem chassis and tyres with a large footprint.

High performance technology in conjunction with soil conserving tyres helps to maintain soil health and protect the sward.

Soil compaction can have a direct effect on your profits. Deep wheel marks cost up to 10 % more diesel. Damage due to compaction can result in fertiliser costs up to 20 % higher.

Cost efficiency as a key element to success

"The loader wagon really helps to save costs. You need much fewer personnel and the soil is less compacted because you only need one machine instead of two, three, four or even five in the field. So the loader wagon has many advantages."

Steven Bowen
Contractor
Church Stretton | Great Britain

Cost effectiveness

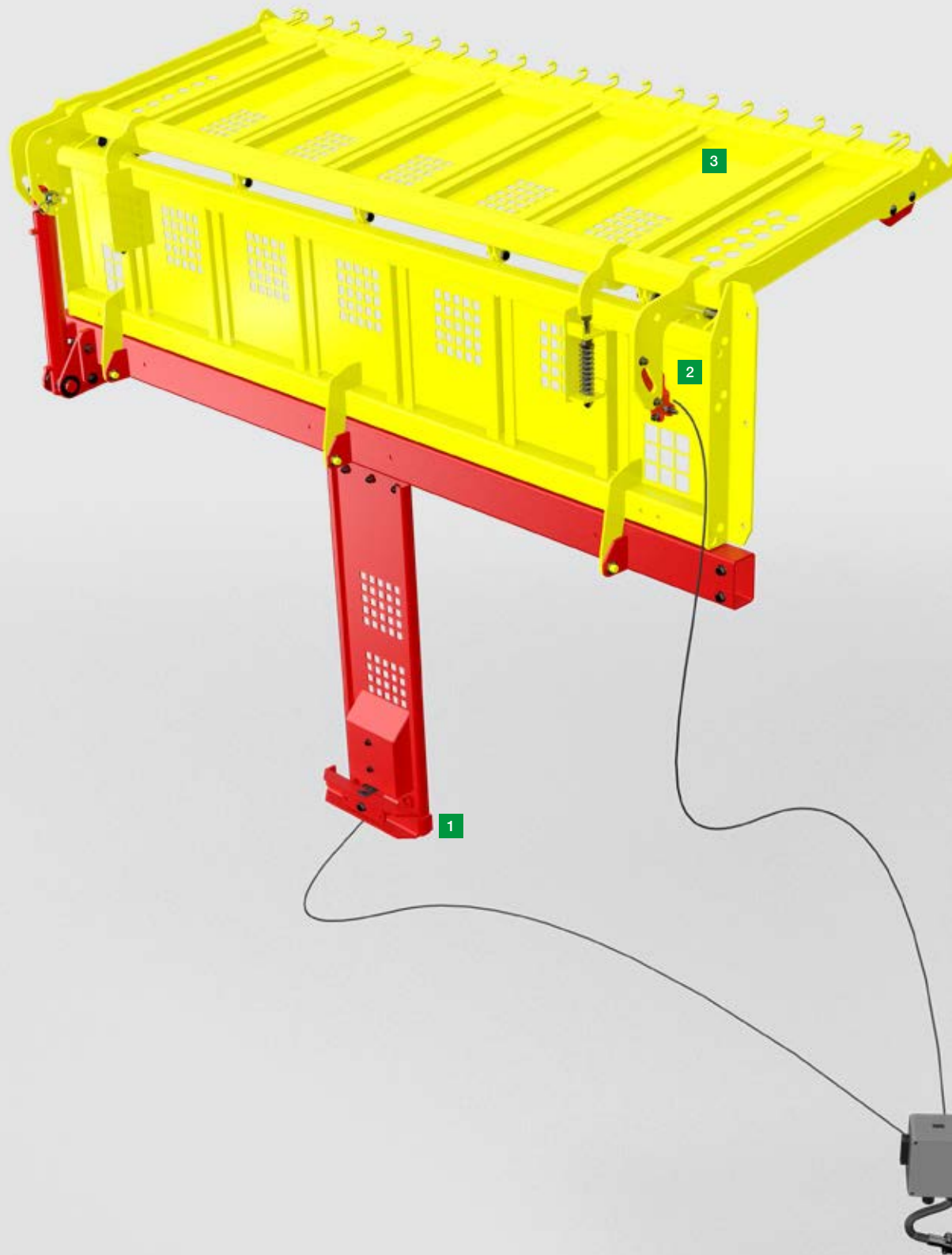

- 1 Front panel sensor
- 2 Compression flap sensor
- 3 Forage compression flap
- 4 Job computer

FARO / FARO COMBILINE

Forage conservation and cost effectiveness at the highest level

The smooth delivery of power during loading is what makes a modern loader wagon with an automatic loading system stand out. A sensor in the front panel of the loader wagon in combination with the forage compression flap ensures optimum forage structure even in difficult and changing harvesting conditions. The loading strategy can be adjusted conveniently from the tractor cab.

The volume of the loader wagon can then always be utilised in the most effective way to maximise cost effectiveness.



Reliability



Reliability

Due to constantly growing demands in terms of output with ever shorter harvest time windows, it is all the more important to have a reliable machine available.

Quite simply, it's always ready to go!

Regardless of whether in wet or dry conditions, for straw or silage, the FARO picks up crops reliably in all operating conditions.

A controlled floating pick-up

The 6 row pick-up is controlled from both ends by a steel cam track.

The tines are slightly trailed to sweep in a controlled arc and adapt ideally to contours. Clean forage is guaranteed as a result.

The fully active tine length up to the withdrawal point ensures the forage is transferred to the rotor perfectly.

Thanks to the reduced speed of the rotor, the forage is not dragged through. It is fed into the rotor actively.

This guarantees maximum conveying performance at high driving speeds and a reliably high intake performance in differing harvesting conditions.

FARO / FARO COMBILINE



FARO 5010 L for contract work

Service and reliability are important factors for our farmers and for me as an agricultural services provider.

While we are at work in the field, customers constantly monitor us in terms of raking and chopping quality, and whether the loader wagon is properly filled.

Because of its light weight, the FARO 5010 L is also often booked as a harvest transport wagon in our hilly region. Another argument in favour of the PÖTTINGER loader wagon as far as I am concerned is value retention: the high resale value after years of operation and the easily accessible service centre in Landsberg.

Richard Neumayr
Contractor
Kaufbeuren | Germany

Reliability



Strength with the highest quality

The rugged frame construction is made using high quality QStE fine grained steel. Frame and side pillars are fastened using fine thread bolts - no welds. High-strength side profiles and closely-spaced pillars ensure the highest strength.



High quality components

Durability and top performance - characteristics that PÖTTINGER is committed to delivering. Using the highest quality components is a central criterion. That is why we manufacture our parts from the highest quality materials.

Continuous testing and ongoing development

To further develop its product ranges, PÖTTINGER continually invests in Research & Development and expanding its own test centre at the Technology and Innovation Centre (TIZ), the cornerstone of its quality assurance system. Here, we test our products as to their suitability in field conditions in order to pass on only the very best to our customers. Our testing centre is one of the most modern in agricultural technology worldwide.

FARO / FARO COMBILINE

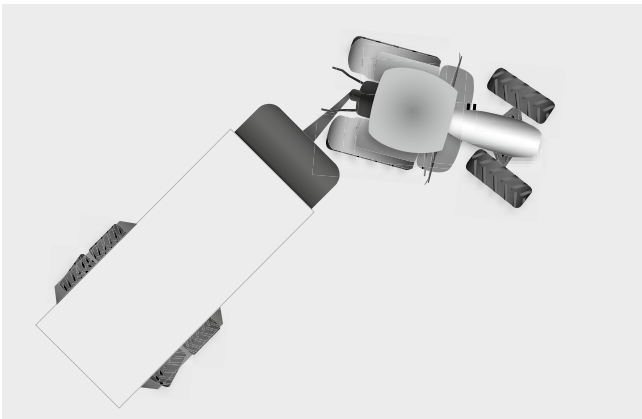

Rugged drawbar

Depending on the type of tractor, the tyres fitted, and the type of mounting, a turning angle in excess of 60° is possible thanks to the narrow design of the drawbar.



High or low drawbar

For drawbars which support a load of up to 2 t, a parallel lift drawbar with two double acting cylinders are fitted as standard. A drawbar shock absorber is available as an option. A folding parking stand makes it easy to attach and detach.



Load sensing

All PÖTTINGER loader wagons are load-sensing compatible.
The required oil flowrate is precisely measured and adjusted to demand. This prevents the oil from heating up and reduces the power requirement by up to 20 hp (15 kW).

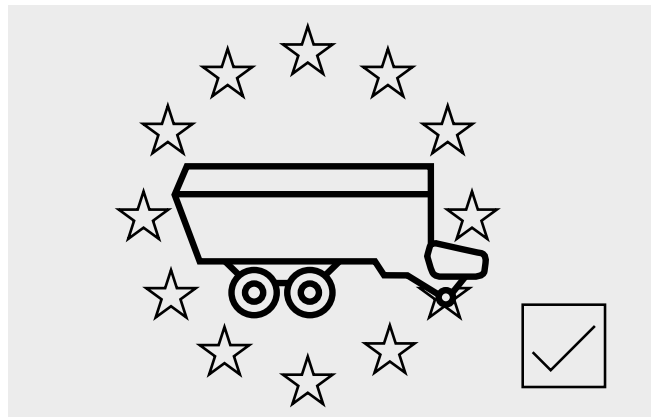

EU type approval

All PÖTTINGER loader wagons are engineered according to the latest requirements of EU type approval for agricultural vehicles VO (EU) 167/2013.
The loader wagon is defined as a trailer and allocated to vehicle class R.

Reliability



Conserving soil and increasing profit

Look after the health of your soil.
Choose the right tyres, conserve the sward and increase your profit.

With the right tyres, there is no contradiction in using high output technology and conserving the soil. In order to protect soil as a natural resource, ensure sustainable soil fertility and maintain soil performance, you need to make sure that loads are distributed uniformly. Using the largest possible dimension of wheels increases the footprint of the tyres so that the soil structure is maintained in the best possible way.

- 1 cm deep wheel marks cost up to 10 % more diesel*).
- Damage to the sward can cause yield losses amounting to 100 €/ha*).
- Heavy compaction can result in fertiliser costs up to 20 % higher.

Using high performance technology in conjunction with modern tyres that conserve the soil will continue to drive competitive agriculture in the future.

FARO tyre chart with an axle load of 6.5 t

Tyre size	Payload per wheel	Tyre pressure	Footprint	Pressure on ground
500/50-17	3,250 kg	2.8 kPa	1.128 cm ²	2.83 kg/cm ²
520/50R17	3,250 kg	2.9 kPa	1.225 cm ²	2.60 kg/cm ²
560/45R22.5	3,250 kg	2.4 kPa	1.434 cm ²	2.22 kg/cm ²
620/40R22.5	3,250 kg	2.2 kPa	1.377 cm ²	2.31 kg/cm ²
710/35R22.5	3,250 kg	2.0 kPa	1.744 cm ²	1.86 kg/cm ²

FARO tyre chart with an axle load of 8 t

Tyre size	Payload per wheel	Tyre pressure	Footprint	Pressure on ground
620/40R22.5	4,000 kg	2.9 kPa	1.369 cm ²	2.87 kg/cm ²
710/35R22.5	4,000 kg	2.6 kPa	1.675 cm ²	2.39 kg/cm ²



Tandem axle with compensator arm

The compensator arm distributes the axle load evenly between the two axles. When driving over rough ground, the weight is distributed evenly. As a result the pressure on the ground is reduced and an equal braking effect is produced on all 4 wheels.

Solid leaf or parabolic springs provide the necessary suspension. These give you a really smooth ride in the field, on the road and in the clamp.

The wide spring support of 1,100 mm is a great advantage when driving along contours and in the clamp.

Tandem axles with parabolic springs and longitudinal linkage

The stronger chassis has longitudinal linkage axle guidance and larger axles with compensator arm.

The compensator arm ensures an even distribution of the axle load on all 4 wheels in all operating conditions. The wide spring spacing of 1100 mm provides the best suspension characteristics.

- Axle spacing 14 t: 1450 mm for optimised driving performance with long vehicles
- Axle spacing 16 t: 1250 mm for smoother ride on roads and steep terrain. Excellent track following properties.

	Tandem axle Leaf springs 10.5 t, 17"	Tandem axle Parabolic springs compensator arm 13 t, 17"	Tandem axle Parabolic springs compensator arm 13 t, 22.5"	Tandem axle Parabolic springs, longitudinal linkage 14 t, 22.5"	Tandem axle Parabolic springs, longitudinal linkage 16 t, 22.5"
FARO 3510	■	□	-	-	-
FARO 4010	■	□	□	-	□
FARO 4010 COMBILINE	-	-	■	-	□
FARO 4510	-	■	□	-	□
FARO 5010	-	■	□	-	□
FARO 8010	-	■	□	□	-
FARO 10010	-	-	-	■	-

■ = Standard, □ = Optional

Reliability





Trailed steered axle

No damage to sward, even with really heavy loads. The ISOBUS terminal automatically locks the trailed steering axle at high driving speeds and when reversing.

Optional equipment.



"Intelligent trailed axles" driver assist system

This enables you to lock the axle automatically in all operating conditions even without ISOBUS.

A direction-of-rotation sensor axle detects the direction of rotation along with the speed and locks the axle within the defined speed range.

The inclination sensor also locks the axle when the defined inclination is reached.

If the defined inclination value is exceeded, you can also have a warning displayed on the control terminal screen.



Braking systems

Pneumatic brakes

The four wheel air brake system with automatic load-dependent braking system (ALB) ensures safe and smooth braking at high speed.

Hydraulic brakes

Hydraulic brakes can be supplied dependent on local legislation.

Loading rotor wagon





Loading rotor wagon



Loading rotor wagon

You get the smoothest operation, high output, strength and reliability with the FARO loader wagon with loading rotor. The entry-level loader wagon with loading rotor is the most cost-effective choice for harvesting quality silage thanks to its smooth running and excellent chopping quality.

Power requirement: 90 to 150 hp
Load volumes: 24 or 52 m³
Pick-up width: 1.85 m

Each type of farm operation expects flexible transport volumes and variable wagon heights.

You can configure the perfect wagon for your business starting from two platform heights with 17" tyres (1,070 mm) and 22.5" tyres (1,190 mm).

- 1 FARO 3510, 4010, 4510: Standard structure 1,620 mm, dry forage extension 870 mm
- 2 FARO 3510, 4010, 4510: Standard structure 1,620 mm, all-steel extension 500 mm, roof bars 60 mm
- 3 FARO 3510,4010, 4510: Standard structure 1,620 mm, all-steel extension 500 mm, slot-in roof bars (370, 250, 160 mm)
- 4 FARO 5010 standard: Standard structure 1,620 mm with all-steel extension 700, slot-in roof bars (370, 250, 160 mm)

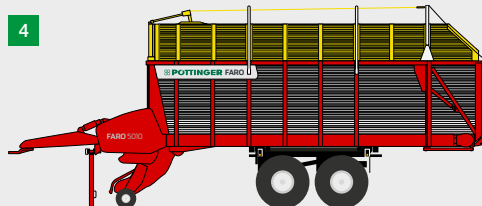
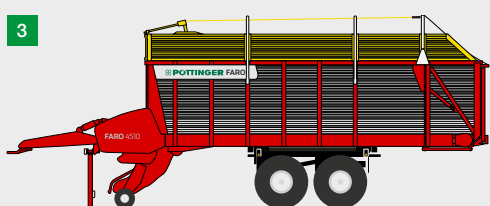
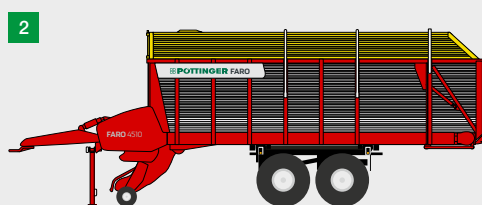
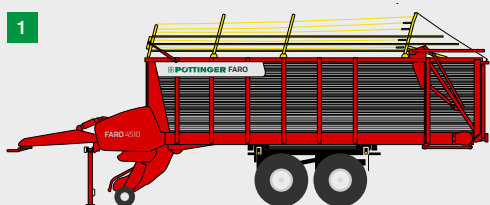

Full flexibility with dry forage extension panels

The FARO range offers a wide variety of loading chamber configurations.

To increase versatility, a version with a folded height of 2,960 mm is available in addition to the standard all-steel structure.

Variable height all-steel structure

Three enclosed chamber versions are available.

The advantage of an all-steel structure is that the forage can be loaded and transported reliably and easily in all areas of application without any losses. Low clearance entrances and livestock units sometimes require reduced vehicle heights.

The roof extension bars can be adjusted to lower the overall height.

The profiled plates have a special coating to guarantee a long service life.

The large surface area of the forage compression flap in connection with the optional automatic loading system ensures the best compression of the crop and maximum use of the loading chamber.

Silage and harvest transport wagon





Silage and harvest transport wagon



Silage and harvest transport wagon combined

The FARO 4010 COMBILINE can also be used as a harvest transport wagon, turning it into a cost effective all-rounder.

Power requirement: 90 to 150 hp

Load volumes: 22 or 23 m³

Pick-up width: 1.85 m

- 1 Straight tailgate flap or multifunction tailgate on D model
- 2 Optional roof ropes with rear tarpaulin
- 3 Tapered mudguards
- 4 COMBILINE superstructure



Unloading

Straight tailgate flap

For full utilisation of the loading chamber.

D model with multifunction tailgate

The driveline to the beater rotors is concealed within the frame. The strong drive shaft is protected by a cam-type clutch at 1200 Nm.

Engineered bodywork

The steel profile structure is designed for use as a harvest transport wagon. It can be loaded from above without any problems because it does not need roof bars for reinforcement.

The profiled plates have a special coating to guarantee a long service life. The large surface area of the forage compression flap ensures the best compression of the crop and maximum use of the loading chamber.

It can be equipped with an optional hydraulic cylinder which can be controlled from the tractor seat. This enables a rapid change between pick-up loading and top-fill loading.

Due to the sloped mudguards, no forage is left lying around even in harvest transport mode.

Silage and harvest transport wagon



Automatic loading

The standard, intelligent automatic loading system guarantees that the wagon is filled right up to achieve maximum transport capacity. The forage is already carefully compressed in the transfer throat to make full use of the loading chamber.

A sensor at the lower end of the front panel measures the loading pressure for damp, heavy grass and switches the scraper floor on and off accordingly.

This prevents the forage from being mashed due to excessive load on the loading rotor.

The second sensor in the forage compression flap measures the compression inside the loading chamber. The forage is compressed uniformly and the loading chamber filled to the optimum capacity.

The intelligent automatic loading system can be adapted to the hydraulic output of different tractors.

Tapered mudguards

All FARO COMBILINE wagons are fitted with sloped mudguards and closed frame beams. Nothing is left lying on the mudguards and as a result no crop falls onto the road during transport.

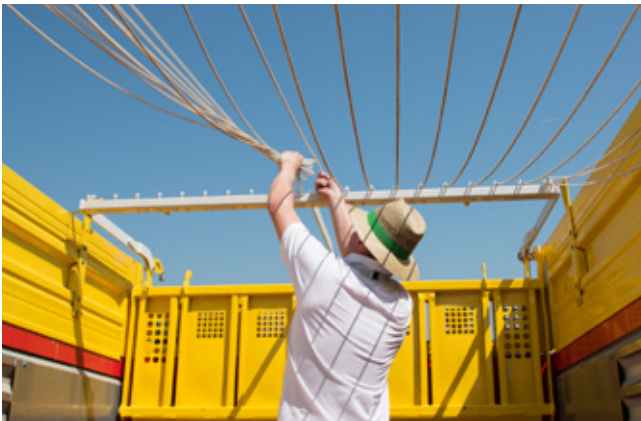

Roof ropes

Roof ropes for a rear tarpaulin are available as an option for crop material with a low density. The roof ropes can be changed quickly and easily. In loader wagon mode, they keep the forage compact inside the loading chamber. They ensure optimum load retention and increase the loading volume by up to 3 m³.



Loader wagon mode

In loader wagon mode, the forage compression flap is folded upwards to allow the flow of the crop into the wagon, which is then regulated by the automatic loading system. Compression is adjustable so it can be set to ideally match the power of the tractor.



Harvest transport mode

In harvest transport mode, the forage compression flap is folded inwards as no crop is being picked up. The optional loading duct cover prevents crop from falling into the rotor duct. Slanting mudguards and smooth structural beams prevent stray crop from being carried out onto the road.

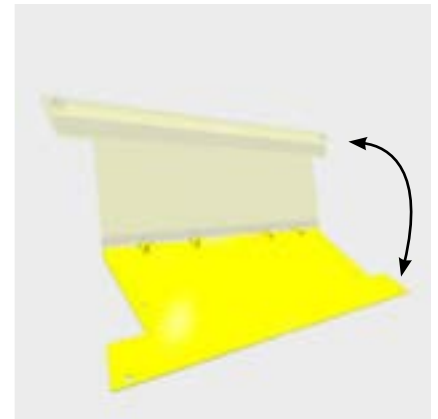

Loading duct cover for harvest transport mode

The optional duct cover prevents crop from falling into the rotor duct while the wagon is being used for transport. On PÖTTINGER wagons the duct cover simply folds away. It does not need to be removed, so changing modes is easy.

High capacity loader wagon for hay and straw





High capacity loader wagon for hay and straw



High capacity loader wagon

PÖTTINGER high capacity loader wagons are in a class of their own and have been especially developed for dry crop specialists.

This kind of work generally involves large field-to-farm distances. In addition, you often need to clear fields rapidly as soon as the combine has finished its work. Both situations can be handled by the high capacity loader wagon. It is the only way to ensure efficiency and cost effectiveness.

Power requirement: 90 to 150 hp

Load volumes: 48 or 52 m³

Pick-up width: 1.85 m

The FARO 8010 L DRY FORAGE and 10010 L DRY FORAGE high capacity loader wagons offer the optimum solution.

- 1 High volume extension with an outside width of 2.55 m
- 2 Large tailgate for an additional loading volume of 1.5 m³
- 3 Roof profiles for max. load density with straw
- 4 Special tandem chassis with an axle spacing of 1450 mm



Automatic loading

The automatic loading system guarantees that the wagon is filled to achieve maximum transport capacity. The forage is already carefully compressed in the transfer throat to make full use of the loading chamber.

Thanks to the consistent loading rate, the automatic loading system provides the basis for high quality ventilated hay.

Sensors mounted in the front panel and upper panel section

A sensor at the lower end of the front panel measures the loading pressure and switches the scraper floor on and off accordingly.

This prevents disintegration of the forage as a result of too high pressure at the conveyor tines.

The second sensor in the forage compression flap measures the compression inside the loading chamber. The forage is compressed uniformly and the loading chamber filled to the optimum capacity.

High capacity loader wagon for hay and straw



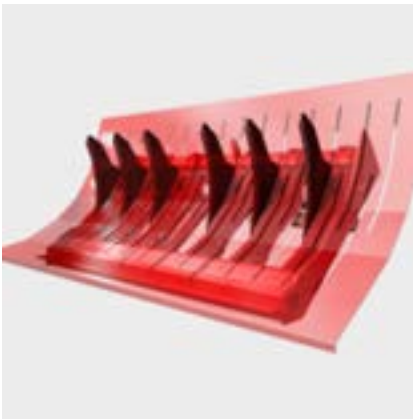

6 knife hay chopping system

The 6 knife chopping system creates the basis for the best quality basic ration with the right chopped length.

The trend in hay ventilation requires suitable forage structures. Using efficient technology for harvesting, ventilation and drying will conserve good quality hay and increases the utilisation of its protein value.

The chopping system is also available with 11 knives as an option.



Roof profiles

The optional roof profiles are fixed to the frame to ensure a high degree of compaction of the crop.

- High compression with low density harvest material
- Highest capacity load with straw and maize straw



Add-on extension panels

For large field to farm distances and a high load density, fully enclosing the loading chamber has proven to be a good solution.

This effectively prevents forage loss and increases load retention.

- 1 Add-on panels
- 2 Extension

Intelligent operation and ISOBUS terminal



A shared language

How machine and tractor communicate, even if they are from different manufacturers

Communicating in a common language is what stands behind the term ISOBUS. The need for this stemmed from the fact that each agricultural machinery manufacturer originally developed its own electronics solution. This was an obstacle for any farmer whose machinery consists of equipment from different manufacturers. ISOBUS refers to the standardised communication system between tractor and implement using standardised hardware and software that is not limited to a single manufacturer: This really makes your daily work a great deal easier.

More convenience using ISOBUS

ISOBUS eliminates isolated solutions by establishing a standardised, compatible connection between tractor and implement, which should work with all combinations using plug and play: Simply plug the ISOBUS plug into the

ISOBUS socket and you are ready to go. A single ISOBUS terminal replaces the large number of implement-specific terminals inside the tractor cab.

Source: www.aef-online.org

The right solution for every requirement

A modern ISOBUS system consists of various components, including tractor, terminal and implement. It always depends on what the terminal and attachments are able to do in each situation and what equipment options have been installed. This is where the ISOBUS functions come into play.

ISOBUS functions are independent modules or building blocks within the ISOBUS system. These work as soon as they are included in all the components involved.

Digital agricultural technology



DIRECT CONTROL Electronic control system

Standard on FARO L models.

The convenient electronic DIRECT CONTROL system is used especially for the PÖTTINGER loader wagon range without unloading beaters. The functions are performed directly at the push of a button without pre-selection or an additional spool valve. The display provides information about the functions and status of the loader wagon.



POWER CONTROL electronic control system

Optional on FARO models.

With the POWER CONTROL terminal you can operate all ISOBUS-compatible PÖTTINGER machines. The functions are performed directly at the push of a button without pre-selection or an additional spool valve. The most important keys are labelled directly with the machine-specific functions, which helps drivers regardless of whether they have used the machine before or not. The function keys F1 to F4 can be used to operate additional equipment on your machine. The colour display provides at-a-glance information on functions and the operating status of the machine.



EXPERT 75 ISOBUS terminal

Optional on FARO models.

The compact 5.6" EXPERT 75 ISOBUS terminal can be operated both directly via the touchscreen and using keys or a scroll wheel. Safe one-hand operation is supported by the grip bar. The ambient light sensor and the illumination of the function keys ensure convenient handling even at night.



CCI 1200 ISOBUS terminal

Optional on FARO models.

The new 12" CCI 1200 ISOBUS terminal offers the professional farmer a comprehensive function package. The terminal is operated like a tablet using a touchscreen. Navigation is kept simple so you find what you need with just a few taps. The integrated ambient light sensor automatically adjusts the brightness of the display.

Manufacturer-independent, wireless data exchange

Without agrirouter

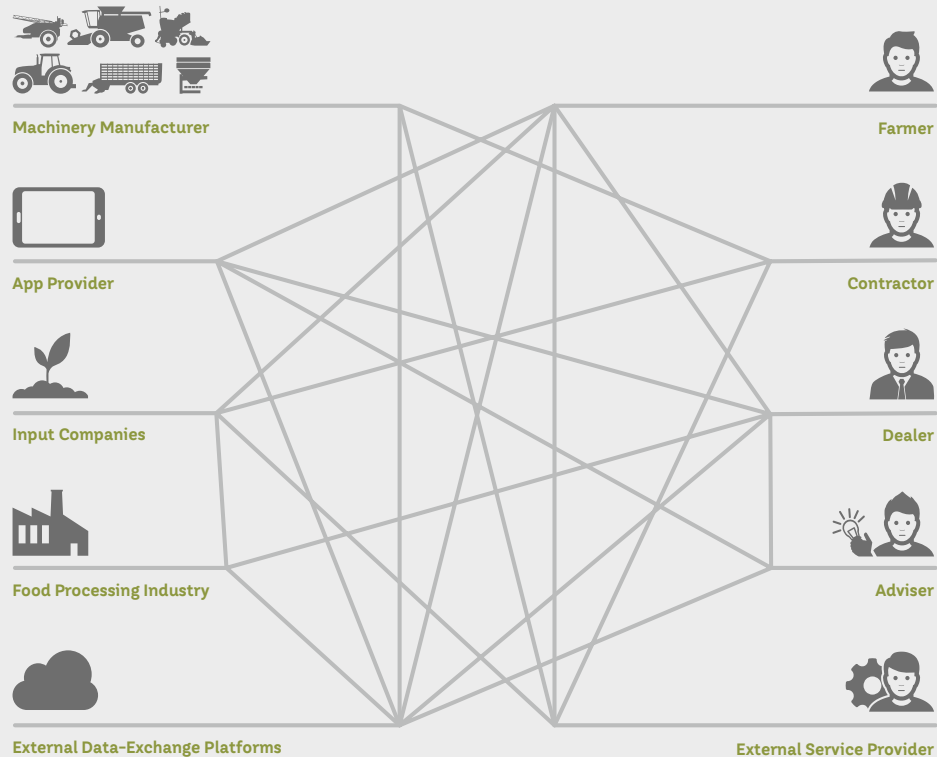

With agrirouter

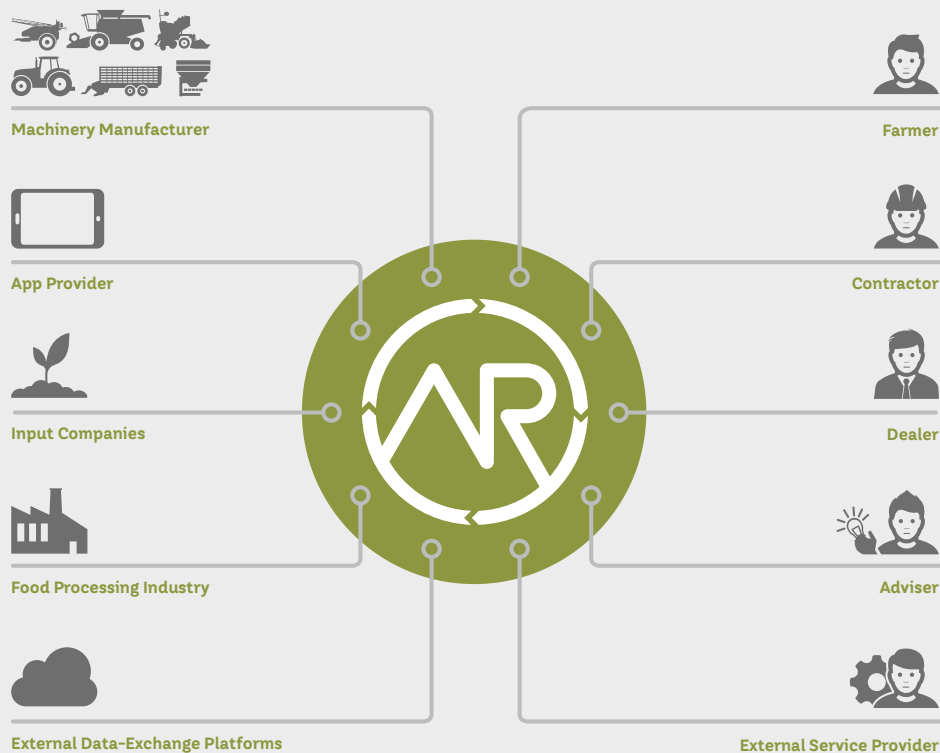

Thanks to the ISOBUS standard, machines from different manufacturers can easily communicate and exchange data with each other. In order to use this data once work has been completed, it makes sense to import it into a farm management system and evaluate it for documentation purposes. While data transfer between agricultural machines from different manufacturers is now straightforward, it has still been difficult to transfer data between machines and software products from different suppliers. This was due to a lack of standards - until now. That is why various agricultural equipment manufacturers, including PÖTTINGER, have joined forces to develop the agrirouter. The agrirouter enables manufacturer-independent, wireless data exchange between machines and agricultural software whilst reducing the number of communication interfaces to a minimum.

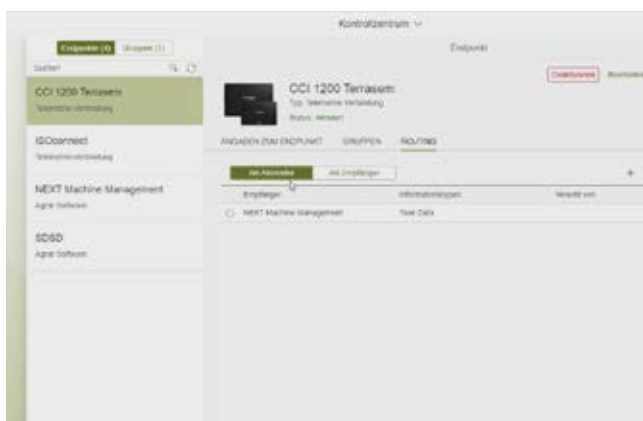

agrirouter - the "data forwarding service"

The agrirouter is a web-based data exchange platform. A free account can be used to send data such as jobs from your field indexing software directly to the CCI 1200 terminal in the tractor. This can also be carried out in the reverse direction by sending machine-related data directly to your farm PC.

Transparency

You define the routes on which the agrirouter transports your data.

Data security

agrirouter does not store any data - you retain full control.

We are ready for agrirouter

You can use the agrirouter for sowing technology in conjunction with our VITASEM and AEROSEM with electric metering drives and TERRASEM seed drills. In the harvesting sector, our ISOBUS-compatible loader wagon range FARO, EUROPROFI, TORRO and JUMBO can be connected to the agrirouter.

These machines are able to document and make available data that is meaningful in terms of the work carried out. This data can be sent wirelessly from the tractor to the office as a standardised ISO-XML file using the CCI 1200 terminal. Likewise, you can send jobs wirelessly from your farm management system to the CCI 1200 terminal in the tractor. You no longer need a USB drive for data transfer. Even a machine fleet from a variety of manufacturers poses no problem for data transfer via agrirouter, provided the respective manufacturer is a member of the agrirouter consortium.

More information can be found at www.my-agrirouter.com

Accessories

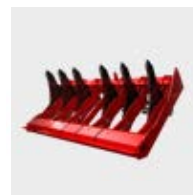
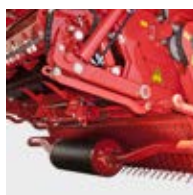

	POWER CONTROL	EXPERT 75 CCI 1200 CCI ISOBUS	Additional tracking roller for pick-up	EASY MOVE	Bolt on frame for 6/11 knives
FARO 3510 L	<input type="checkbox"/>	<input type="checkbox"/>	<input type="checkbox"/>	<input type="checkbox"/>	<input type="checkbox"/>
FARO 3510 D	<input checked="" type="checkbox"/>	<input type="checkbox"/>	<input type="checkbox"/>	<input type="checkbox"/>	<input type="checkbox"/>
FARO 4010 L	<input type="checkbox"/>	<input type="checkbox"/>	<input type="checkbox"/>	<input type="checkbox"/>	<input type="checkbox"/>
FARO 4010 D	<input checked="" type="checkbox"/>	<input type="checkbox"/>	<input type="checkbox"/>	<input type="checkbox"/>	<input type="checkbox"/>
FARO 4510 L	<input type="checkbox"/>	<input type="checkbox"/>	<input type="checkbox"/>	<input type="checkbox"/>	<input type="checkbox"/>
FARO 4510 D	<input checked="" type="checkbox"/>	<input type="checkbox"/>	<input type="checkbox"/>	<input type="checkbox"/>	<input type="checkbox"/>
FARO 5010 L	<input type="checkbox"/>	<input type="checkbox"/>	<input type="checkbox"/>	<input type="checkbox"/>	<input type="checkbox"/>
FARO 5010 D	<input checked="" type="checkbox"/>	<input type="checkbox"/>	<input type="checkbox"/>	<input type="checkbox"/>	<input type="checkbox"/>
<hr/>					
FARO 4010 L COMBILINE	<input type="checkbox"/>	<input type="checkbox"/>	<input type="checkbox"/>	<input type="checkbox"/>	<input type="checkbox"/>
FARO 4010 D COMBILINE	<input checked="" type="checkbox"/>	<input type="checkbox"/>	<input type="checkbox"/>	<input type="checkbox"/>	<input type="checkbox"/>
<hr/>					
FARO 8010 L DRY FORAGE	<input type="checkbox"/>	<input type="checkbox"/>	<input type="checkbox"/>	-	<input checked="" type="checkbox"/> / <input type="checkbox"/>
FARO 10010 L DRY FORAGE	<input type="checkbox"/>	<input type="checkbox"/>	<input type="checkbox"/>	-	<input checked="" type="checkbox"/> / <input type="checkbox"/>

More equipment options

- Automatic high and low drawbar positions for transport and loading (with POWER CONTROL)
- Hydraulic brakes
- Tyres: 520/50R17, 620/40R22.5", 710/35R22.5"
- Trailing jockey wheels for pick-up
- Hydraulic pick-up weight alleviation
- Rear switch for scraper floor
- Load sensing
- 2-speed motor for scraper floor
- Demarcation lights
- Adjustable tailgate strut
- Loading chamber and work lights
- LED floodlights on front panel and mudguards

- LED package (loading chamber, tailgate, pick-up, chopping system with POWER CONTROL)
- Video system with monitor and camera
- Flashing beacon for loader wagons
- Access door with ladder
- 3rd beater rotor
- Cross conveyor belt
- Duct cover for harvest transport mode

Additional equipment for DRY FORAGE:

- Roof profiles
- Add-on panel

Often ordered together.



Automatic loading	Low drawbar	Drawbar damper	Parabolic leaf springs 13 t	Parabolic leaf springs 16 t	Trailed axles
<input type="checkbox"/>	<input type="checkbox"/>	<input type="checkbox"/>	<input type="checkbox"/>	-	-
<input type="checkbox"/>	<input type="checkbox"/>	<input type="checkbox"/>	<input type="checkbox"/>	-	-
<input type="checkbox"/>	<input type="checkbox"/>	<input type="checkbox"/>	<input type="checkbox"/>	<input type="checkbox"/>	<input type="checkbox"/>
<input type="checkbox"/>	<input type="checkbox"/>	<input type="checkbox"/>	<input type="checkbox"/>	<input type="checkbox"/>	<input type="checkbox"/>
<input type="checkbox"/>	<input type="checkbox"/>	<input type="checkbox"/>	<input checked="" type="checkbox"/>	<input type="checkbox"/>	<input type="checkbox"/>
<input type="checkbox"/>	<input type="checkbox"/>	<input type="checkbox"/>	<input checked="" type="checkbox"/>	<input type="checkbox"/>	<input type="checkbox"/>
<input type="checkbox"/>	<input type="checkbox"/>	<input type="checkbox"/>	<input checked="" type="checkbox"/>	<input type="checkbox"/>	<input type="checkbox"/>
<input type="checkbox"/>	<input type="checkbox"/>	<input type="checkbox"/>	<input checked="" type="checkbox"/>	<input type="checkbox"/>	<input type="checkbox"/>
<input checked="" type="checkbox"/>	<input type="checkbox"/>	<input type="checkbox"/>	<input checked="" type="checkbox"/>	<input type="checkbox"/>	<input type="checkbox"/>
<input checked="" type="checkbox"/>	<input type="checkbox"/>	<input type="checkbox"/>	<input checked="" type="checkbox"/>	<input type="checkbox"/>	<input type="checkbox"/>
<input checked="" type="checkbox"/>	<input type="checkbox"/>	<input type="checkbox"/>	<input checked="" type="checkbox"/>	-	<input type="checkbox"/>
<input checked="" type="checkbox"/>	<input type="checkbox"/>	<input checked="" type="checkbox"/>	-	-	<input type="checkbox"/>

Configure your own machine.

■ = Standard, □ = Optional

Technical data

FARO L COMBILINE	Load capacity DIN volume Volume DIN with roof ropes	Pick-up Intake width	Knives knife spacing	Loading area length/width
4010 L COMBILINE	40 m ³ 23 m ³ 24.5 m ³	1.85 m	31 pcs 45 mm	5.68/2.10 m

FARO D COMBILINE	Load capacity DIN volume Volume DIN with roof ropes	Pick-up Intake width	Knives knife spacing	Loading area length/width
4010 D COMBILINE	40 m ³ 22 m ³ 23.5 m ³	1.85 m	31 pcs 45 mm	5.68/2.10 m

FARO L	Capacity	Pick-up Intake width	Knives knife spacing	Loading area length/width
3510 L	24 m ³	1.85 m	31 pcs 45 mm	5.00/2.10 m
4010 L	27 m ³	1.85 m	31 pcs 45 mm	5.68/2.10 m
4510 L	30 m ³	1.85 m	31 pcs 45 mm	6.36/2.10 m
5010 L	33 m ³	1.85 m	31 pcs 45 mm	6.36/2.10 m
8010 L DRY FORAGE	48 m ³	1.85 m	11 pcs 135 mm	7.73/2.10 m
10010 L DRY FORAGE	52 m ³	1.85 m	11 pcs 135 mm	9.14/2.10 m

FARO D	Capacity	Pick-up Intake width	Knives knife spacing	Loading area length/width
3510 D	23 m ³	1.85 m	31 pcs 45 mm	4.75/2.10 m
4010 D	26 m ³	1.85 m	31 pcs 45 mm	5.43/2.10 m
4510 D	29 m ³	1.85 m	31 pcs 45 mm	6.11/2.10 m
5010 D	32 m ³	1.85 m	31 pcs 45 mm	6.11/2.10 m

FARO / FARO COMBILINE

External dimensions length/width	Overall height Overall height with roof ropes	Standard unladen weight	Permissible total weight	Maximum total weight
8.41/2.51 m	3.35 m 3.675 m	6.35 t	15 t	18 t

External dimensions length/width	Overall height Overall height with roof ropes	Standard unladen weight	Permissible total weight	Maximum total weight
8.88/2.51 m	3.35 m 3.675 m	6.85 t	15 t	18 t

External dimensions length/width	Overall height with 17" tyres 22.5" tyres	Standard unladen weight	Permissible total weight	Maximum total weight
7.78/2.42 m	3.56 m -	5.55 t	12.5 t	15 t
8.46/2.42 m	3.56 m 3.68 m	5.65 t	12.5 t	18 t
9.14/2.42 m	3.56 m 3.68 m	5.80 t	15 t	18 t
9.14/2.42 m	3.76 m 3.88 m	5.85 t	15 t	18 t
10.79/2.55 m	3.98 m 4.00 m	6.55 t	15 t	16 t
11.99/2.55 m	- 4.00 m	7.70 t	16 t	16 t

External dimensions length/width	Overall height with 17" tyres 22.5" tyres	Standard unladen weight	Permissible total weight	Maximum total weight
8.25/2.42 m	3.56 m -	5.95 t	12.5 t	15 t
8.93/2.42 m	3.56 m 3.68 m	6.05 t	12.5 t	18 t
9.61/2.42 m	3.56 m 3.68 m	6.20 t	15 t	18 t
9.61/2.42 m	3.76 m 3.88 m	6.35 t	15 t	18 t

All machine information at a glance

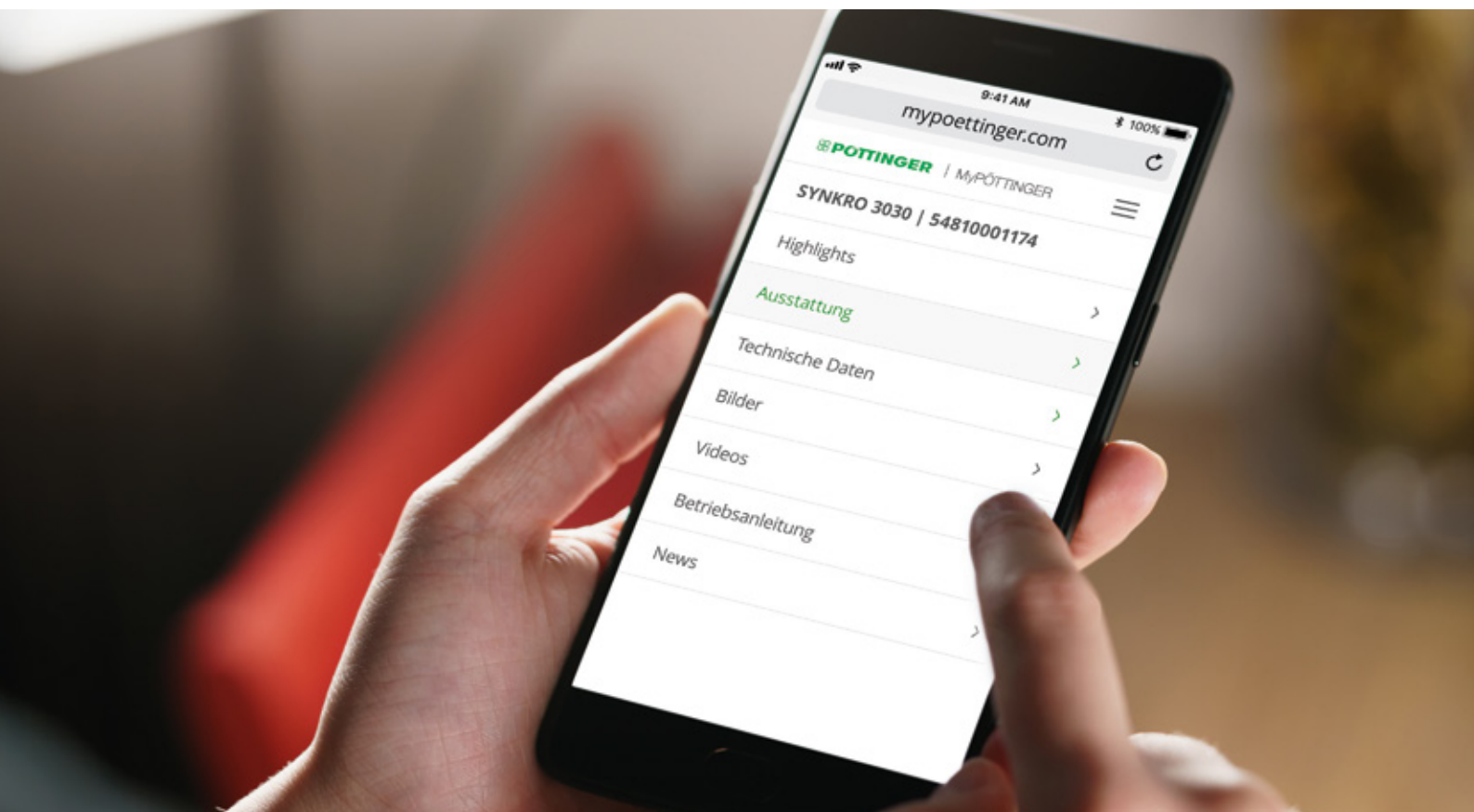

MyPÖTTINGER – Simple. Anytime. Anywhere.

For all PÖTTINGER machines 1997 models onwards

We have created MyPÖTTINGER as a tool to provide machine specific information for all machines from year of build 1997 onwards.

Simply scan the QR code on the data plate with your smartphone or tablet or enter your machine number at www.mypoettinger.com.

Your machine goes online

You will immediately receive all the information on your machine.

- Instruction manual
- Optional equipment information
- Brochures
- Photos and videos.

ORIGINAL PARTS



CLASSIC

DURASTAR

DURASTAR PLUS

Rely on the original

PÖTTINGER Original Parts meet the highest demands in terms of functionality, reliability and performance. These are characteristics that PÖTTINGER is committed to delivering.

That is why we manufacture PÖTTINGER Original Parts from the highest quality materials. We ideally match each individual spare part and wear part to your machinery's overall system. This is because different soil and operating conditions often need to be taken into consideration.

We have been listening to our customers and now offer three different lines - CLASSIC, DURASTAR and DURASTAR PLUS - to make sure you have the right part to meet every requirement. Original parts are worth every cent, because know-how cannot be copied.

Your advantages

- Immediate and long-term availability.
- Maximum durability thanks to innovative production processes and the use of the highest quality materials.
- Avoidance of malfunctions due to a perfect fit.
- The best working results thanks to optimum match to the overall system of the machine.
- Save time and costs thanks to longer replacement intervals on wear parts.
- Comprehensive quality testing.
- Ongoing advancement through research and development.
- Worldwide spare parts supply.
- Attractive, competitive prices for all spare parts.

Wear parts

The CLASSIC line is for standard duty applications. With these ORIGINAL INSIDE parts we have defined the benchmark for quality, best price/performance ratio and reliability.

DURASTAR is the innovation on the wear components market - durable, high quality, productive and reliable.

Are you used to putting your machines to work in the most extreme conditions? Then the DURASTAR PLUS line is the right choice for you.



More Success with PÖTTINGER

- A family-owned company since 1871.
Your reliable partner.
- Specialist for tillage, seed drills,
hay and harvesting machines
- Future-safe innovation for outstanding working results
- Roots in Austria - at home throughout the world

Harvest quality

- Perfect ground tracking delivers a cleanly collected crop with minimal crude ash content
- Best chopping quality and a consistent chop length for the highest quality silage
- High loading rate, high loading volume, high torque protection and smooth running
- Excellent reliability, even in difficult harvesting conditions

Ask for more information:

PÖTTINGER Landtechnik GmbH

Industriegelände 1
4710 Grieskirchen
Austria
Phone +43 7248 600-0
info@poettinger.at
www.poettinger.at

Alois PÖTTINGER UK Ltd.

15 St Marks Road, Corby
Northamptonshire,
NN18 8AN
United Kingdom
Phone + 44 1536 272 220
info@pottinger.uk
www.pottinger.uk

POETTINGER Canada Inc.

460 Rue Robinson Sud
Granby, QC, J2G 7N6
Canada
Phone +1 450 372 5595
Fax +1 866 417 1683
info@poettinger.ca
www.poettinger.ca

POETTINGER US, Inc.

393 Pilot Drive
Valparaiso, IN 46383
USA
Phone +1 219 510 5534
Fax + 1 219 707 5412
info@poettinger.us
www.poettinger.us

PÖTTINGER Australia PTY LTD

11 Efficient Drive
Truganina VIC 3029
Australia
Phone +61 3 8353 2770
info@poettinger.com.au
www.poettinger.com.au

POETTINGER Ireland Ltd.

Glenaleamy, Powerstown Road,
Clonmel, Co. Tipperary
Ireland
Phone +353 52 6125766
info@poettinger.ie
www.poettinger.ie

Importer for New Zealand:

Origin Agroup
PO Box 673, 57 Hautapu Road
Cambridge
New Zealand
Phone +64 7 823 7582
info@originagroup.co.nz
www.originagroup.co.nz

Importer for South Africa:

VALTRAC
Cnr. Water & Buiten Street
9585 Parys
South Africa
Phone +27 56 817 7338 7308
wynn@valtrac.co.za
www.valtrac.co.za